



**be different.
make a difference.**

Thermal Systems / E-Cooling

Solutions for electric & hybrid systems

What we cool in electrified vehicles?

power units



- electric motors
- generators

power electronics



- inverter
- converter
- controller

energy storage



- batteries
- capacitors

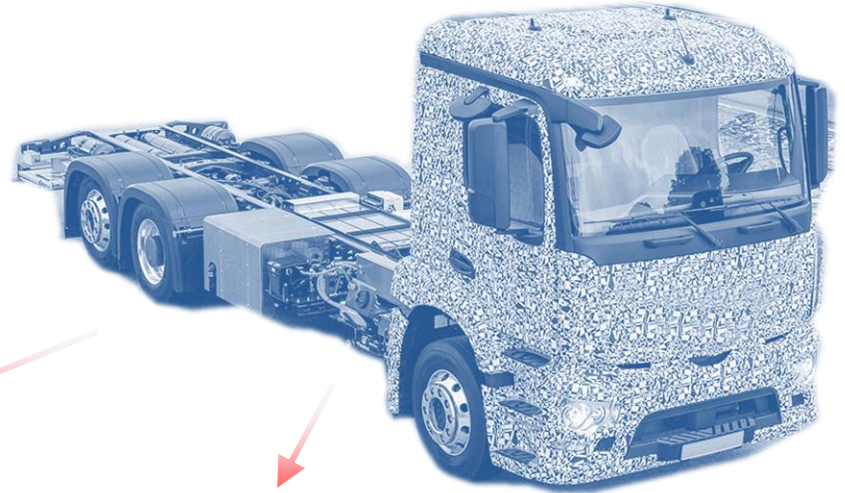

Products & Solutions for EV components



Controlling temperature according to its best working range

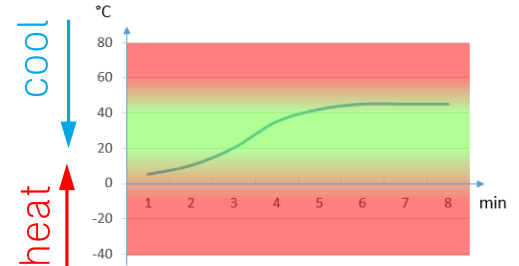
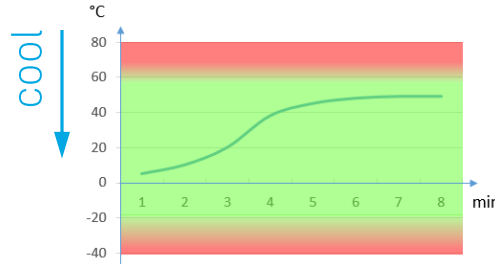
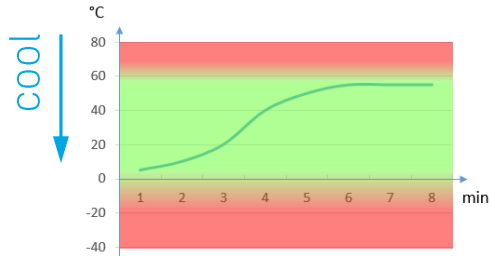

cooler



pump



tank



cooler



pump



tank



e-cube

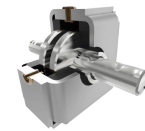

mounts



cold plate

Products & Solutions for EV components



One source for components and complete systems

cooler module



cooling water with ambient air
or separate fluid circuit

pump module



for use in water cooling circuit

tank module



expansion tank for water circuit

Select from a wide range of technologies, performances and options

Complementary Products

Available technologies and options

cold plate

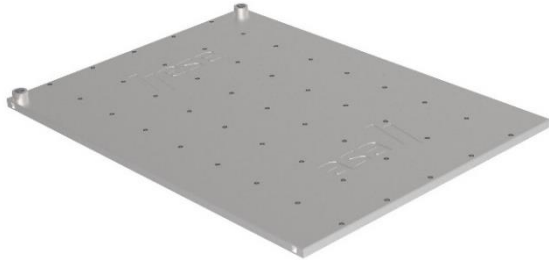

cooling of battery packs

- highest heat transfer
- robust plate and bar design
- customized to application

vibration control

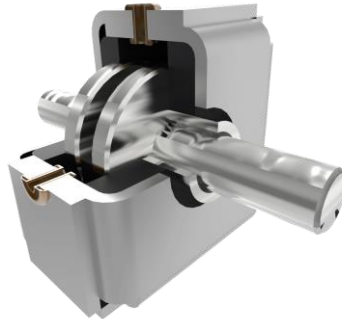

mounting batteries and elements

- break-proof installation
- highest shear loads
- stainless steel option

brushless motors



motor and pump drives

- PWM / analog (0...10V)
- high flow version for long vehicles

Reference Projects

Electrification of the drum drive of concrete mixer trucks

Truck mounted, electrically driven drum

Control temperature of electric motor and power electronics

Components for water-glycol

- water cooler
- expansion tank
- pump

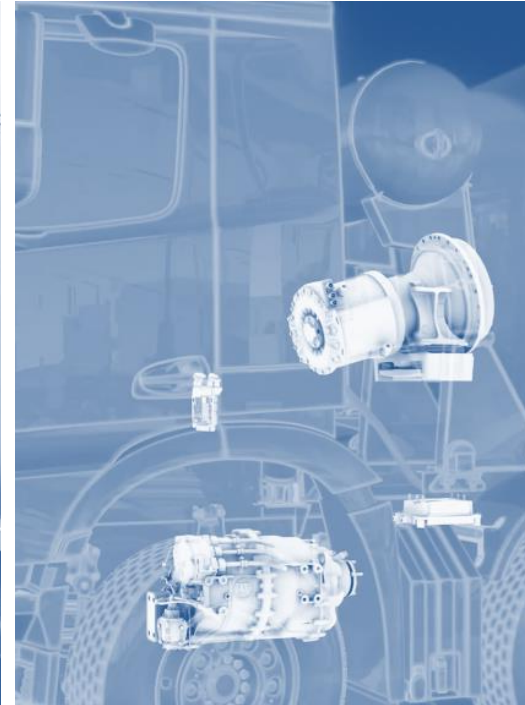

Reference Projects

Hybrid Truck

Efficient heat transfer during charge and discharge process.

water/glycol cold plate for battery packs
24V brushless water pump
heat exchanger TT 11 with brushless fan motor

complementary product:

oil cooler for cooling the cable surface of stationary charging unit.

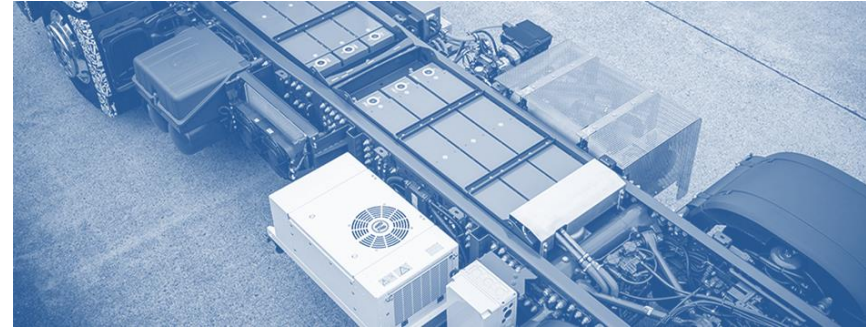

Reference Projects

Full electric excavator

2t to 16t excavator

Cooling the circuits:

- hydraulic (ISO VG46)
- battery and e-motors (water/glycol)

2x oil/air cooler TT 11 rail 24V DC



Reference Projects

E-axle for agricultural machine

Electric drive axle to support the conventional power train

TT 11 rail 12V DC GT

- protection housing,
- fan speed control,
- vibration absorbers
- G 1" rail connectors

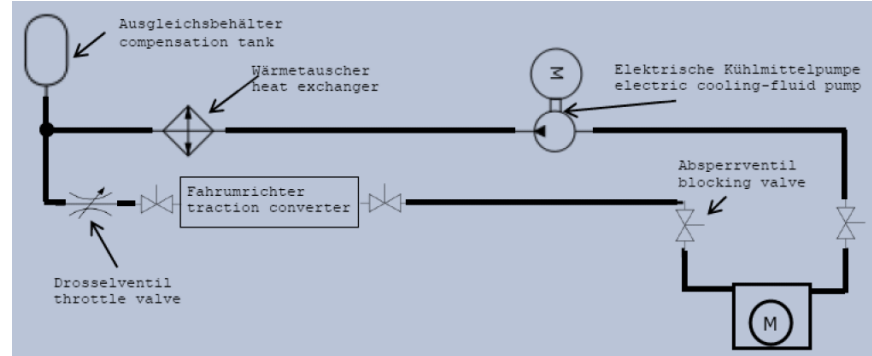

Other E-Loop Products

Stationary Applications

- cooling of a transformer grid system with horizontal mount AC drive cooler
- support of power electronics and battery packs with wire vibration mounts for highest corrosion protection or break proof mounts for best practice vibration control.

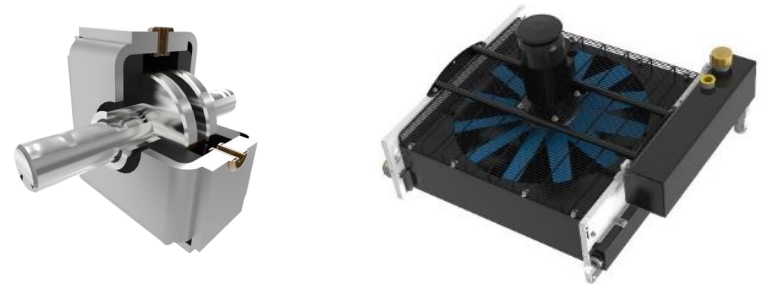

Get in contact!



AUSTRIA

asa hydraulik GmbH
Prager Strasse 280
A-1210, Vienna

USA

asa hydraulik of America
160 Meister Avenue 20 A
Branchburg, New Jersey 08876

INDIA

ASAhdraulik India Pvt Ltd
C1/102/9,GIDC,Palej, Dt.Bharuch
Gujarat - 392220

www.asa-innovation.com
support@asa-innovation.com
+43 1 292 40 20

CHINA

asa Technology (Suzhou) Co., Ltd.
Jiangsu Suzhou Industrial Park
Fangzhou Road No 128,
area 6, building B

AUSTRALIA

asa Products Pty Ltd
Bentley Street 4/15
3016 Williamstown, Victoria

